

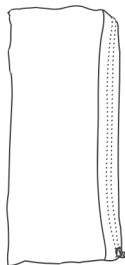

Foldable/Expandable Waterproof Bag Manual

Model: BWB30

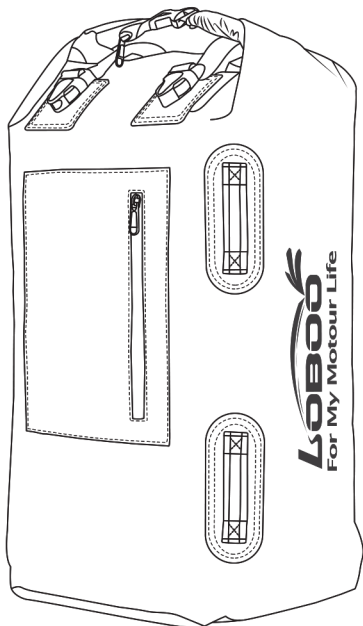

*Please read this manual carefully before using this product to avoid improper use causing product damage.



Scan QR Code To Watch
The Installation Video

Parameter

Model: BWB30

Capacity: 30L

Dimensions: Length 500mm/19.69in * Width 300mm/11.81in



* Height 200mm/7.87in (Expanded form)

Length 295mm/11.61in * Width 125mm/4.92in

* Height 60mm/2.36in (Folded form)

Material: Nylon, TPU

Accessories List

Serial Number	Name	Diagram	Quantity	Remarks
①	Foldable/Expandable Waterproof Bag		1 pc	
②	LOBOO Quick Release Strap		2 pcs	

Product Details

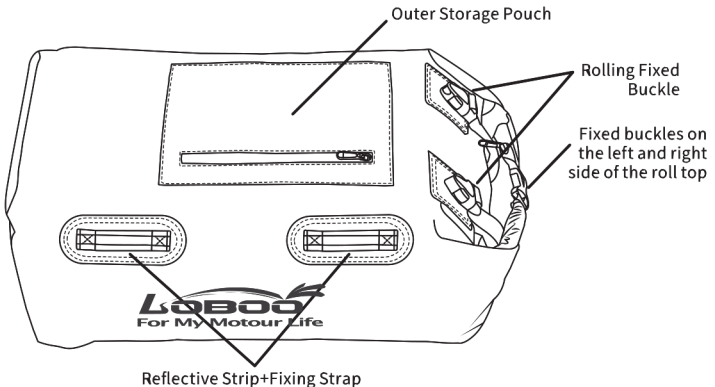

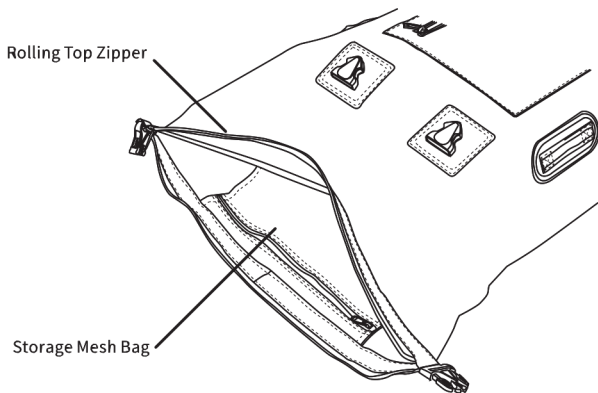

Instruction

Expansion

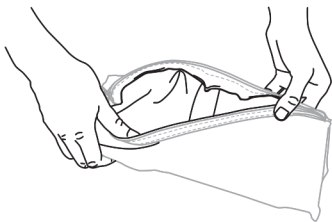

1. Flip out the main body of the product.

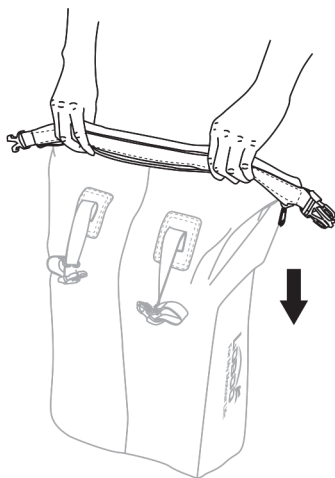

2. After putting in the items, close the rolling top zipper, and fold it down three times (IPX6 level waterproof performance).



3. Connect the fixed buckles on the left and right of the rolling top.

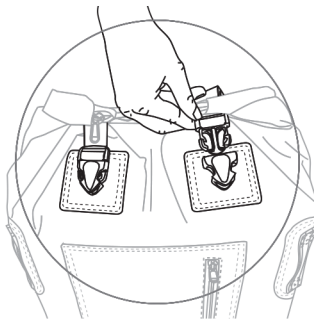

4. Rolling fixed buckle:
Connect the rear middle buckle with the front middle fixed buckle, and adjust the length of the woven belt to tighten the woven belt lock buckle.

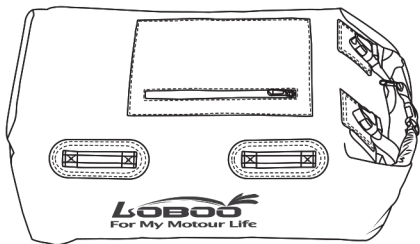

5. Operation completed.

Folding Storage

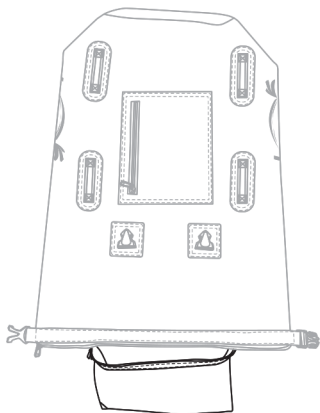

1. Lay out the product, and flip the inside of the storage mesh bag out.

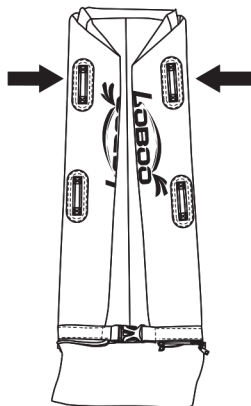

2. Flip to the back, tighten the fixed buckles on the left and right sides, and fold the sides towards the middle.

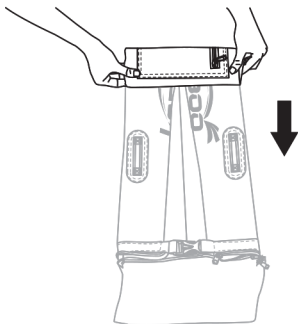

3. Rolling the bag from bottom to top.

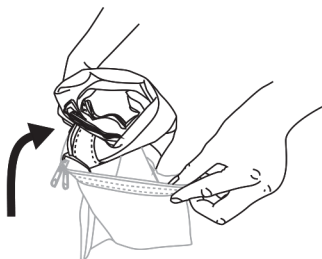

4. Put the main body of the product into the storage mesh bag in the opposite direction of the roll.

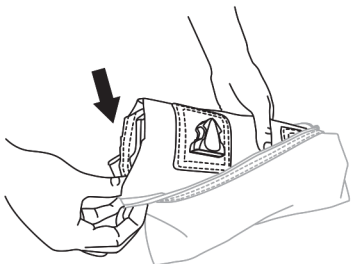

5. Put the main body of the product in.

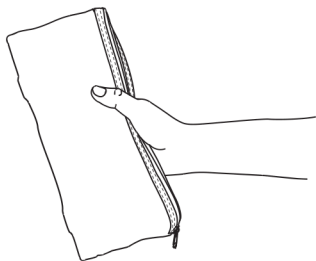

6. Operation completed.

Fixation

LOBOO Quick Release Strap x 2

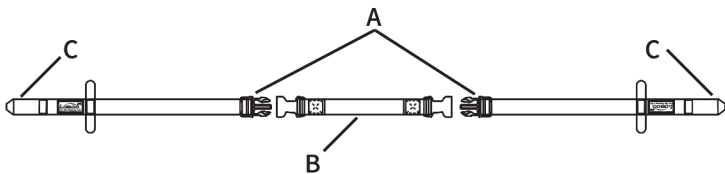

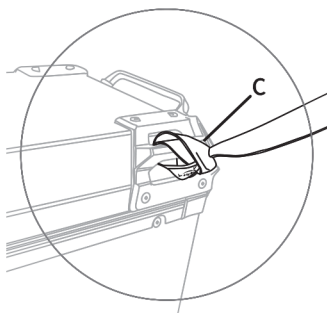

1. On the lid of the motorcycle trunk, use C to tie 4 fixed points respectively, as shown in the figure.

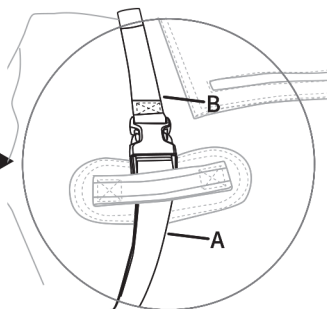

2. Connect LOBOO quick release traps A and B, pass through the limit strap and directly bind the waterproof bag.

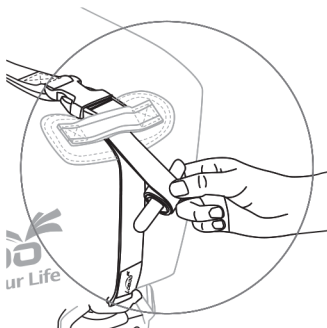

3. After tightening, adjust the length of the woven belt storage belt and stick the Velcro.



4. Operation completed.

Precautions For Use

1. After each use, wipe off the stains on the surface of the tail bag with a soft damp cloth and soap (do not use bleach, fabric softener or other acidic and alkaline cleaners), do not machine wash, comfirt ironing, dry cleaning and any form of drying, let it dry naturally, do not expose it to the sun for a long time.
2. When not in use for a long time, the tail bag should be placed in a dry and cool environment to avoid mildew causing damage to the tail bag; and regularly clean the dust and dirt on the surface of the tail bag to extend its service life.
3. Before going out, check the handle, shoulder strap and quick release strap of the tail bag to avoid aging affecting normal use. When using in harsh outdoor environments, do not use insect repellent on the surface of the tail bag. Please avoid sharp objects scratching the tail bag fabric during use to avoid affecting the waterproof performance.

Warranty Card



Please read this after-sales service guarantee card carefully. If you cannot accept it, please contact the dealer for return and exchange in time. Installation and use means acceptance of this after-sales service term.

After-sales Service Terms

1. One-year free warranty period, this product can enjoy free repair service within one year from the date of sale if there are quality problems under normal circumstances.
2. Limited warranty: After the one-year warranty period expires, LOBOO will provide paid warranty service, the cost is based on the actual replacement material cost, and no labor cost is charged separately.

Free warranty service does not include the following

1. No warranty card or cannot provide valid purchase proof.
2. Improper installation, use, man-made or accidental damage, self-disassembly, self-modification and repair, etc.

Return and Exchange Information

Platform ID: _____ Order Number: _____

Contact Name: _____ Contact Phone: _____

Return Address: _____

Description

Please keep this card properly and send it back with the product (copy is valid)

